

Divergence Meter

User manual v2.0.3

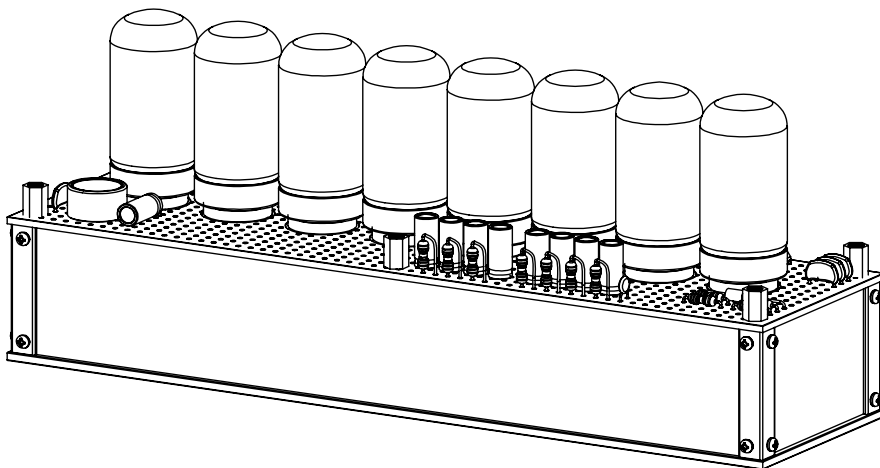

Designer: Yan Zeyuan. China
Website: <http://www.nixieclock.org>
E-mail: yanzeyuan@163.com

 NIXIE CLOCK HOME | 辉光钟之家
YanZeyuan's DIY Studio

Attention

- ◇ Attention: To prevent accidental damage, do not place Divergence Meter on an uneven surface.
- ◇ Warning: The Divergence Meter has an internal high voltage circuit, DO NOT open; DO NOT touch the components while the Divergence Meter is operating.
- ◇ Warning: In order to ensure normal operation and charging, please use only the included power adapter and USB cable.
- ◇ Warning: The Divergence Meter is for indoor use only.
- ◇ Warning: Please do not let children touch the Divergence Meter.

Catalogue

Introduction	
Package Contents.....	5
Appearance.....	6
IR Remote.....	7
Power Adapter.....	7
Features.....	8
Technical Specifications.....	9
Get Ready Before Use	
Power On/Off.....	10
Charging the Battery.....	10
Replace Batteries.....	11
Connect a GPS Receiver.....	12
Cleaning.....	12
Basic Operation	
Soft Power On/Off.....	13
Talking Clock.....	13
Set Volume.....	14
Animations With Music.....	14
Display Divergence Data from the Comics.....	15
Modify the Stored Divergence Data.....	15
Display Time.....	16
Set Time.....	17
Display Date.....	18
Set Date.....	19
Display Alarms.....	20
Set Alarms.....	21
Set Auto On/Off Time.....	22
Display Temperature.....	23
Menu.....	23

Menu Setup 24

Menu 1 Set Time Format.....	24
Menu 2 Set Date Format.....	24
Menu 3 Set Temperature Format.....	25
Menu 4 Set Leading Zeroes.....	25
Menu 5 Set Digital Switching Effects.....	25
Menu 6 Set Digital Switching Speed.....	26
Menu 7 Set Blinking Colon Effect	26
Menu 8 Set Time Display Mode.....	27
Menu 9 Set Clock Reference Source.....	27
Menu 10 Set Baud Rate of GPS.....	27
Menu 11 Set UTC Time Zone.....	28
Menu 12 Set Temperature Compensation.....	28
Menu 13 Set Alarm Sound.....	28
Menu 14 Set Alarm Volume.....	29
Menu 15 Set Talking Clock Language.....	29
Menu 16 Set Interval of Talking Clock.....	29
Menu 17 Set Interval of Divergence Animation.....	30
Menu 18 Set Sound Effect of Power On.....	30
Menu 19 Set Animation Show of Power On.....	30
Menu 20 Display Firmware Version.....	31

Reference

Firmware Upgrade.....	32
Cathode Poisoning Prevention.....	33
Special Remarks.....	33

Package Contents

Before getting started, please check the contents of the package. If any are missing, please contact the seller. Package consists of the following items:

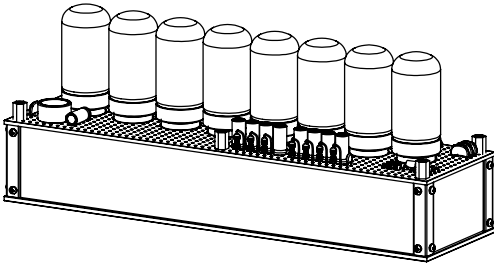

Divergence Meter

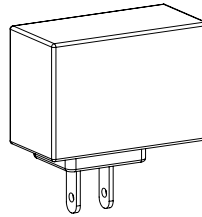

Power adapter

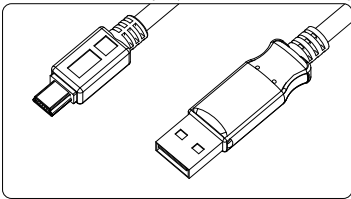

Micro-USB Cable

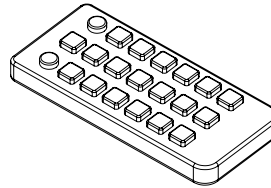

IR remote controller



- The included power adapter has standard USB port rated for 2 Amp max output current, which will allow fast charging during normal operation. DO NOT use other type of USB power supply or computer USB port.
- The included USB cable is rated for 2 Amp current. Use of other types of USB cable will cause improper charging and operation.

Appearance

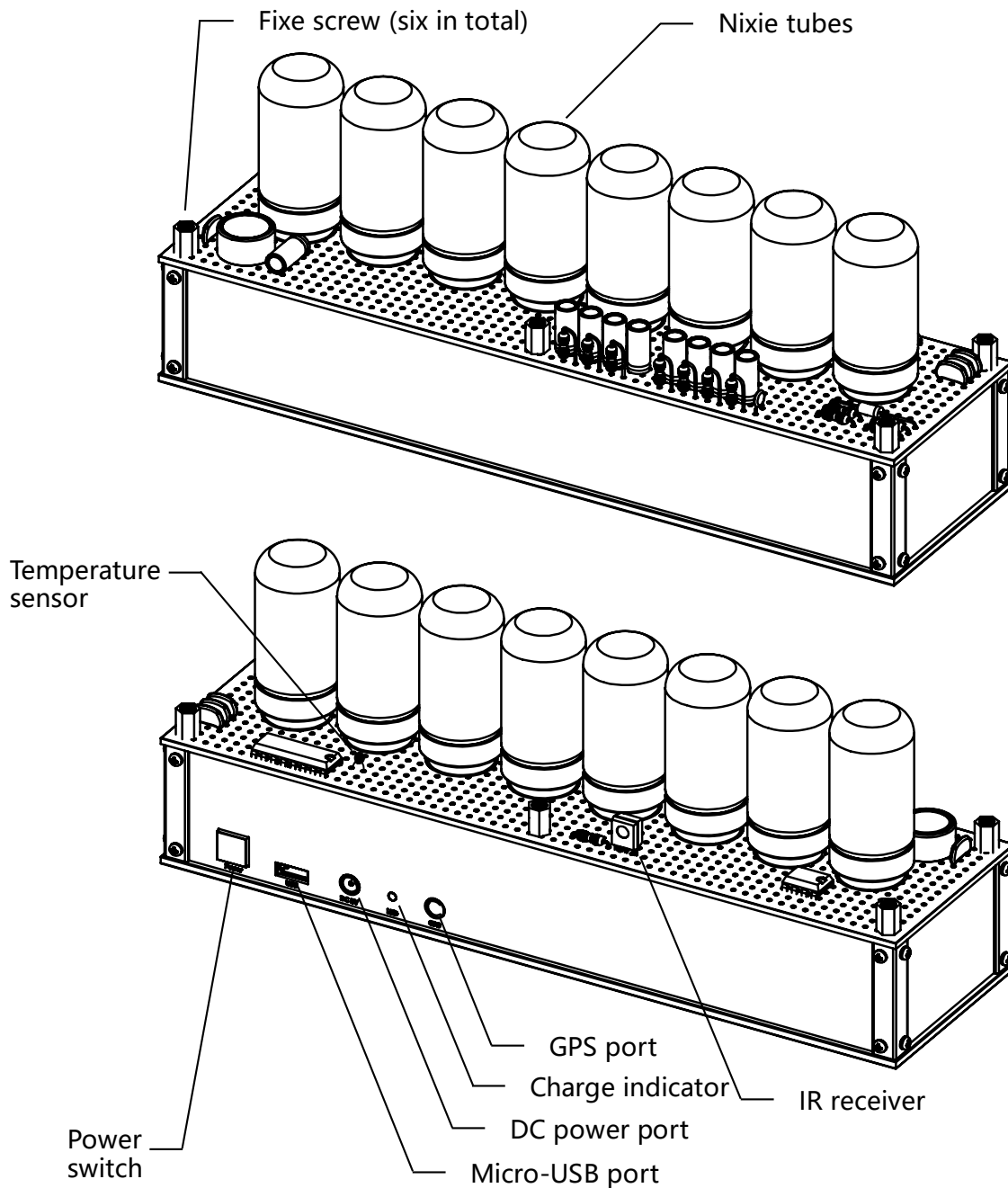

- Three tube variations were designed for Divergence Meter, each has a different appearance.
- EDGE version uses NL-5440A made in the USA.
- Plus version uses IN-8-2 Nixie tubes made in Soviet Union.
- Pro version uses IN-14 Nixie tubes made in Soviet Union.

IR Remote

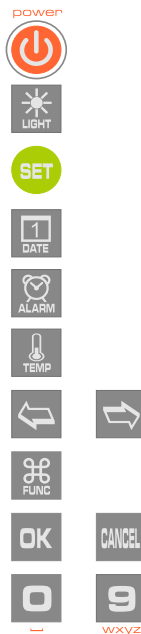

Power	Power ON/OFF
LIGHT	Talking clock
SET	Enter setup
DATE	Check date
ALARM	Display alarm
TEMP	Display temperature
LEFT/RIGHT	Set position
FUNC	Enter menu
OK/CANCEL	Save & exit
NUMBER	Enter numbers



- IR controller uses (1) CR2025 cell. Transportation rules may not permit shipment with lithium battery installed. Please insert battery or remove the protective insulator to operate.

Power Adapter

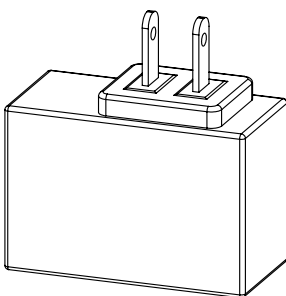

- Global usage voltage ranging:
Input: 100-240VAC, ~0.4A, 50/60Hz.
- Standard USB output.
- Output DC 5V, Max 2000mA.



- In order to insure proper charging and operation, use only the supplied power adapter and high current USB cable.

Features

Divergence Meter has the features of Steins;Gate with animation effects. In addition, Divergence Meter is a full-featured Nixie clock.

- **Nixie clock with eight Nixie tubes**
The EDGE version uses NL-5440A Nixie tubes made in USA; The Plus version uses IN-8-2 Nixie tubes made in Soviet Union; The Pro version uses IN-14 Nixie tubes made in Soviet Union.
- **Real-time clock display**
Display hour, minute and second (12 or 24 hour format optional), leading zero on/off optional. Two different time display mode: Normal 6 digits mode and Divergence Meter mode. Eg: 22:15:20 can be displayed as 22.15.20 or 1.101520.
- **Date display**
Display year, month, day and Chinese lunar date (YY-MM-DD, YY-DD-MM, DD-MM-YY or MM-DD-YY format optional).
- **Alarm**
Four alarm clocks, each of which can be activated individually (weekend activated optional).
- **Temperature display**
Built-in temperature sensor, °C or °F optional.
- **Talking clock**
Intelligent speech system in English, Chinese Mandarin, Japanese and German. The interval and alarm music are user customizable.
- **Volume adjustable**
8 volume levels.
- **Animations as show in the comics**
Up to 10 sets of Divergence data can be saved. The transitions among them have animations.
- **Animations show with music**
Divergence data is shown along with built-in music.
- **Four transition effects for the digits**
1. Normal 2. Fade in-out 3. Crossfading 4. Slot machine.
- **Ten transition speed for the digits**
Ten speeds available for the transition.
- **Four animation effects for the colons**
1. Left and right dot crossfading 2. Left and right dot fade in-out 3. Always lighting 4. Blinking.
- **GPS synchronization**
GPS adjustment with real-time synchronization.(GPS is offered as an option)
- **Switch On/Off automatically**
On and Off-time can be set for longer tube lifetime.

Technical Specifications

Name	Specifications
Nixie tubes	EDGE edition: NL-5440A made in USA
	Plus edition: IN-8-2 made in Soviet Union
	Pro edition: IN-14 made in Soviet Union
Power input	Micro-USB or DC(3.5mm/1.35mm)
Voltage of Micro-USB input	DC 5V
Voltage of DC input	DC 5V
Operation current	Max 900mA (for display only)
	Max 1000mA (for charging only)
	Max 1900mA (for display and charging)
Built-in battery	2pcs Panasonic NCR18650B (capacity 6800mAh)
	Working time 8-10 hours
	Fully charged time 6 hours
GPS requirement	TTL port, 2400-9600bps, 3.5mm headset plug
Dimension	Base 190mm(L) x 50mm(W) x 35mm(H)
	Height of nixie tube 55mm, diameter 19mm
Material of housing	Stainless steel
Operating temperature	0°C to 60°C (32°F to 140°F)
Weight	600g (Only Divergence Meter)
	1200g (Complete packaging)



- Working time of battery depends on the environment temperature and the duration and frequency of operation.
- Time to fully charged depends on remaining battery capacity before charging.

Get Ready Before Use

Power On/Off

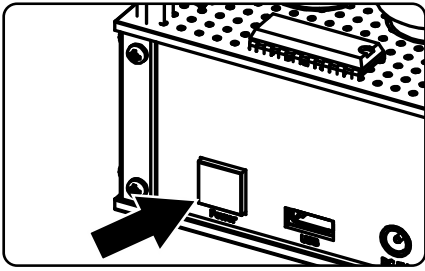

- Turn on the power by pressing the power button on the back.
- Turn off the power by pressing again.
- Lamp on the button will illuminate red when the power is on.

Charging the Battery

- Divergence Meter can operate for 8-10 hours of continuous use with the built-in (2) pcs of fully charged 18650 Lithium batteries.
- Working time of batteries depends on the environment temperature frequency of operation.
- Please charge the battery before use.
Color of indicator during charging:

LED Color	Status
Red	Charging
Green	Charging completed
Off	Charging protection

- Charging will take about 6 hours at room temperature, fully charged time depends on remaining capacity before charging.



- Divergence Meter installed (2)pcs Panasonic NCR18650B 3,400mAh lithium batteries.
- Turn the power off for fast charging.
- Indicator will be green after charging is completed. Unplugging the charger is not required after charging is completed as the system will stop charging the batteries. The charger will power the Divergence Meter directly after charging is completed.
- Please replace batteries if they only last a very short time.

Replace Batteries

- Please remove (6) pcs top screws and top unit before replace batteries.
- Pull up the strap under the batteries to easily remove them. Install new batteries noting the polarity of the original batteries.

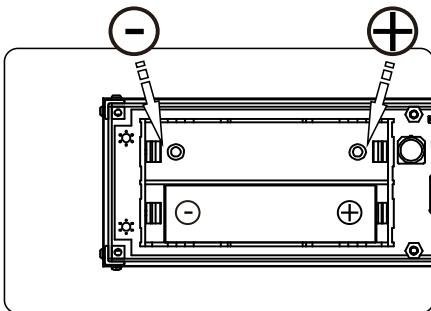
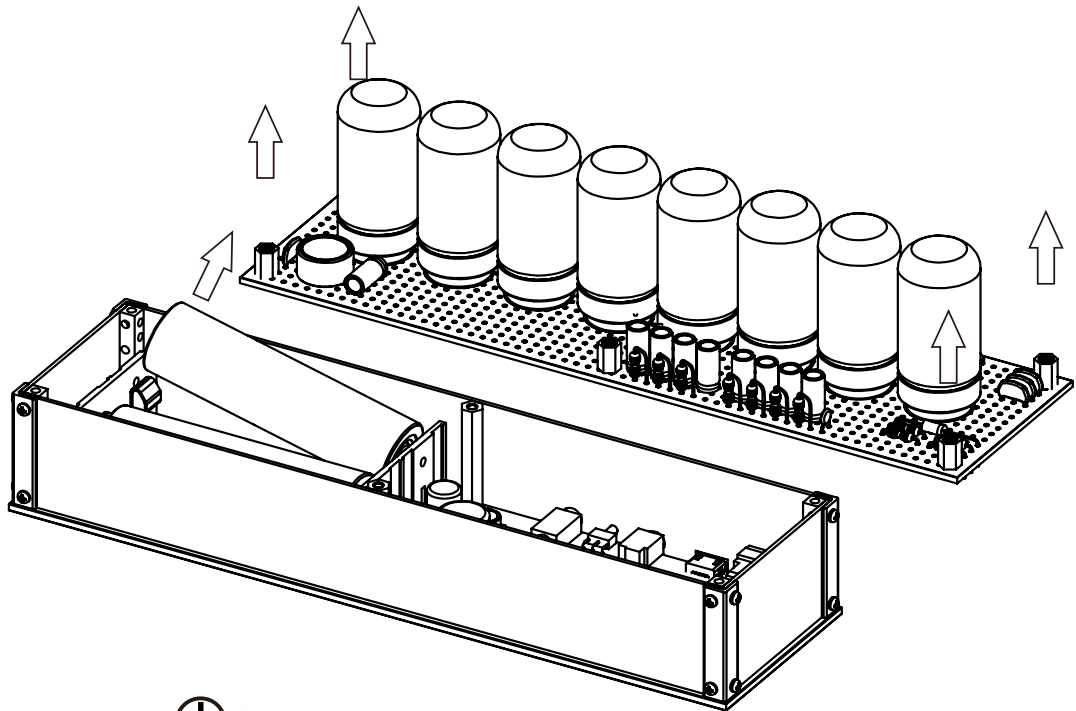

Please note the position of anode and cathode when replacing the batteries.



- Incorrect polarity will damage the Divergence Meter! Please follow the instruction picture above.



- Please use two batteries with same capacity.

Connect a GPS receiver (GPS receiver is optional and may be purchased)

GPS receiver can synchronize the date and time with satellite for high precision time.

- Before connecting GPS receiver, please make sure it has 3.5mm headset plug.
- Please plug in the GPS receiver at the back of the Divergence Meter.
- Please place the GPS receiver outdoor or near a window.
- You can check the connection status at MENU 9.



- We recommend to use only the suggested GPS receivers.
- GPS require TTL interface and following NMEA0183 protocol.
- We support the baud rate of 2400bps, 4800bps and 9600bps.

Cleaning

Consider the notes below before cleaning Divergence Meter.

- Please power off and disconnect USB cable before cleaning.
- Do not use any cleaning agent or wet wiper.
- We suggest use soft cloth or brush to avoid scratching the housing finish.

Basic Operations

Soft Power On/Off

After power on by pressing power button on the back of Divergence Meter, you still can toggle the display on/off by press **POWER** button on IR remote controller.

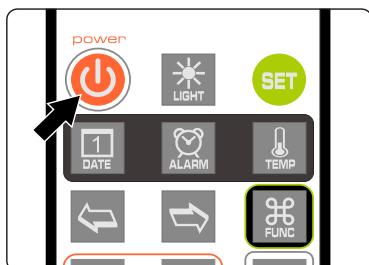

- Press **POWER** button of IR remote to power off.
- Press **POWER** button again to power on.



- Turns off Divergence Meter Nixie tubes display, soft power does not completely turn off the Divergence Meter. Please press the power button on the back if you want totally power off the Divergence Meter.
- To set sound effect of power-on, please consult MENU 18.
- To set animations of power-on, please consult MENU 19.

Talking Clock

Internal phonetic chip can speak the clock time.

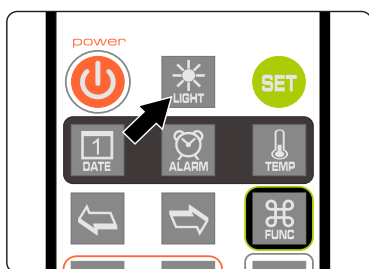

- Press LIGHT button to trigger talking clock.
- Set the time interval of automatic talking clock by following MENU 16.



- Talking clock can be triggered any time.
- Built-in speech system in English, Chinese Mandarin, Japanese and German. Speech system setup at MENU 15.
- Volume of talking clock is controlled by the system volume.

Set Volume

Volume of talking clock or other sound effect can be set to eight levels.

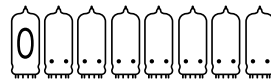
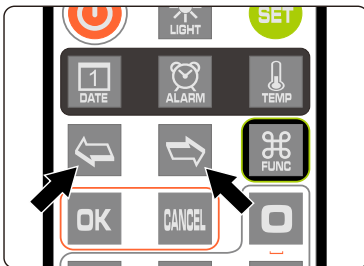

Mute

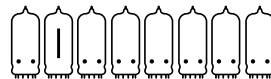

Minimum volume

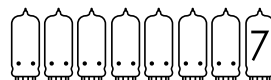

Maximum volume

- Press **LEFT/RIGHT** button to set volume.



- This volume setting is only for talking clock and sound effect during operating. The volume of alarms is independent.
- To set volume of alarms please consult MENU 14.

Checking Battery percent

After press POWER button of IR remote to power off, Divergence Meter will show the battery percent.

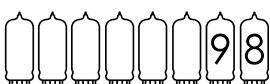

- Digits will show the battery percent on right three tubes.
- Divergence Meter will sound alert every minute when the battery percent under 20%.

Animations with Music

Divergence Meter can show animation with built-in music accompaniment.



- Press **OK** button start animation show.
- Press **CANCEL** button to stop.

Display Divergence Data from the Comics

Divergence Meter can save up to 10 sets of Divergence data. Press 0-9 button to show.



Default divergence data:

0:	0.337187	5:	1.130238
1:	0.571015	6:	1.048596
2:	0.523307	7:	0.456903
3:	0.571024	8:	0.275349
4:	2.615074	9:	1.130426

Modify the Stored Divergence Data

- Please press **0-9** button to select the number of divergence data, then press **SET** button to enter modify mode, then the number on the left will blinking.
- Press **0-9** button input 7 digits to change divergence data.
- All digits will blink three times after the input is completed.
- Press **CANCEL** button to abort.

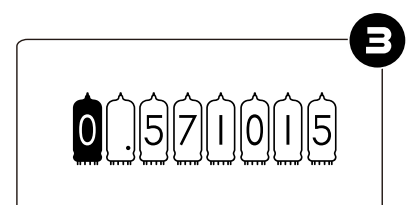
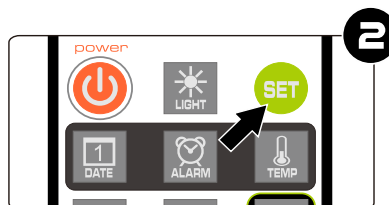

Display Time

- Divergence meter will display real time after power on.
- There are two time display mode: Normal 6 digits mode and Divergence Meter mode.

Eg: now time is PM 10:15:20, will display:

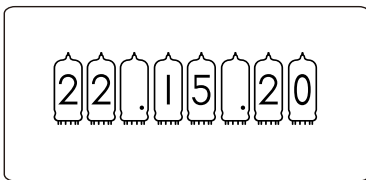

Normal 6 digits mode

- In normal mode: digits on the left are HOURS; digits in the middle are MINUTES; digits on right are SECONDS.
- Colon will display based on the effect setting.

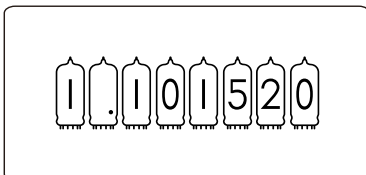

Divergence Meter mode

- In Divergence Meter mode: digits on the left will show you AM(0) or PM(1), 6 digits on the right will show you HHMMSS.



- In normal mode, to set 12/24 time format, please consult MENU 1.
- In normal mode, to set leading 0, please consult MENU 4.
- To control digital switching effect setting, please consult MENU 5.
- To control digital switching speeds setting, please consult MENU 6.
- In normal mode, to set the colon effect, please consult MENU 7.

Set Time

Time can be set manually or synchronize with satellite by the optional GPS receiver. To set time manually:

- Press **SET** button to enter time setting mode, 2 digits on the right start blinking.

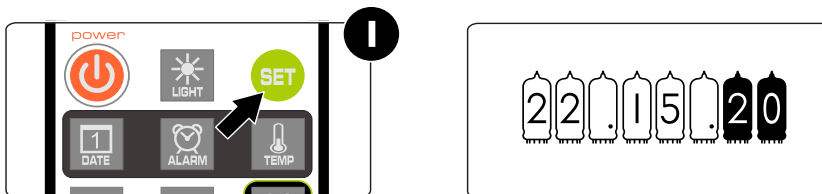

- Press **LEFT/RIGHT** button select position of setting.

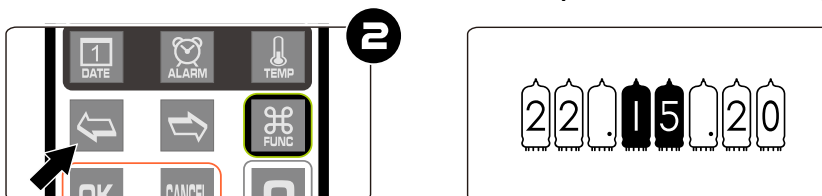

- Press 0-9 button input HOUR, MINUTE or SECOND.

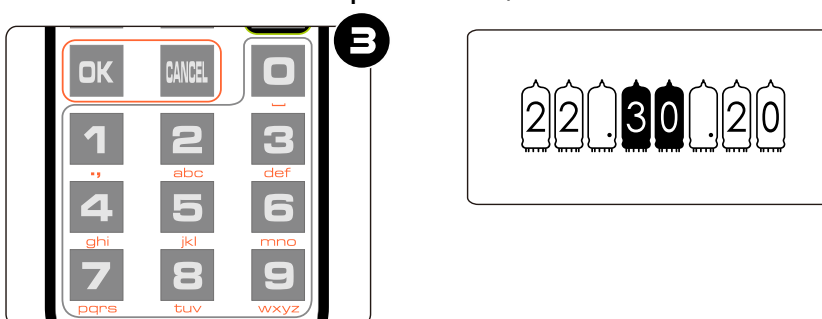

- Press **OK** button to save settings, press **CANCEL** button to abort.

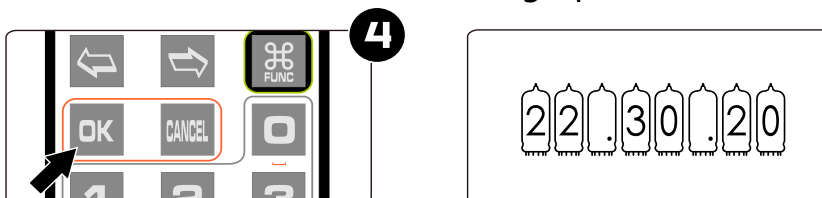

- Time will display in 24 hour mode HH:MM:SS during setting mode.
- Any digits can be input during setting, but system will check if the time is valid when you save it. Invalid time can not be saved.

Display Date

Divergence Meter can display year, month and day and Chinese lunar date.

- Press **DATE** button once to display date; press twice to display Chinese lunar date.

Eg: Now date is 9th Dec 2015, and Chinese lunar date is 2015-10-28.

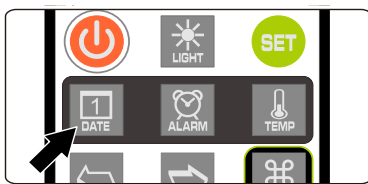

- Press **DATE** button once: shows 2015-12-09
- To easily understand that the date displayed is not the Chinese lunar date, the display will show YY..MM..DD where the 3rd and 6th digits will display two dots.

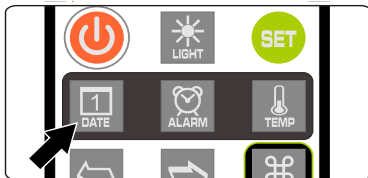
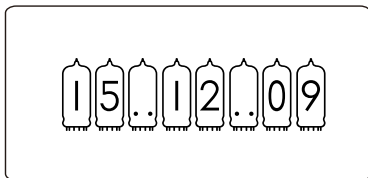

- Press **DATA** button twice: shows 2015-10-28.
- During the display of Chinese lunar date, the 3rd and 6th digits will be blank.

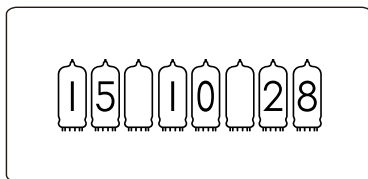

- After 3 seconds of display date, Divergence Meter will return to time display mode.
- Plus version only has one dot in the nixie tubes, so it will display only one dot during date display.
- Date format can show YY-MM-DD, YY-DD-MM, DD-MM-YY or MM-DD-YY, please consult MENU 2 to set the date format.

Set Date

Date can be set manually or synchronize with satellite by the optional GPS receiver.
To set date manually:

- Press **DATE** button to show the date.

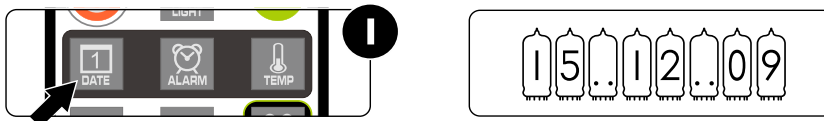

- Press **SET** button to enter set date mode, The 2 digits on the left start blinking.



- Press **LEFT/RIGHT** button to select setting position.

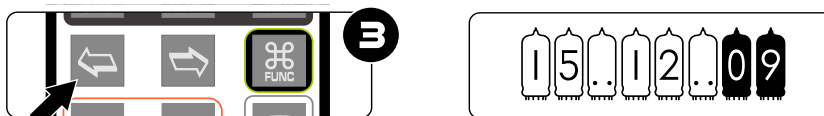

- Press **0-9** button to enter YEAR, MONTH or DAY.

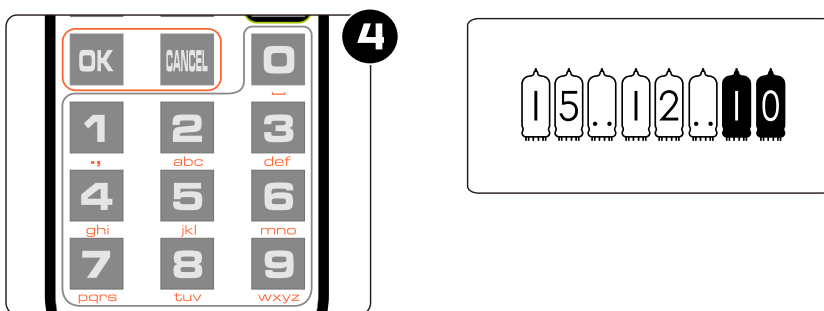

- Press **OK** button to save setting, press **CANCEL** to abort.

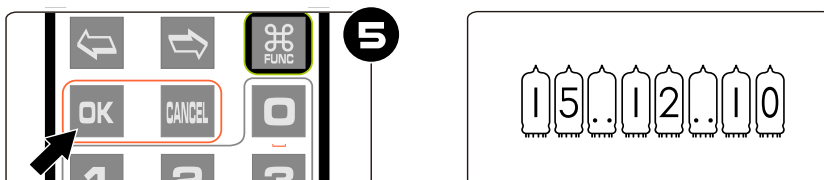

- In setting mode the date format displayed will be YY-MM-DD.
- Any digits can be input during setting, but system will check if the date is valid when you save it. Invalid date can not be saved.
- Chinese lunar date does not need to be set, the system will calculate it automatically.

Display Alarms

Divergence Meter can supports 4 alarms, each can be active separately and active at weekend separately.

- Press **ALARM** button to check alarm 1, and press **ALARM** button twice to check alarm 2, and so on.

Eg: Alarm 1 is set to 8:00 AM.

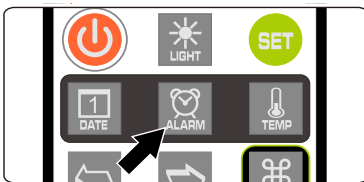

- Press **ALARM** button to display alarm 1 as shown below: 08:00 AM

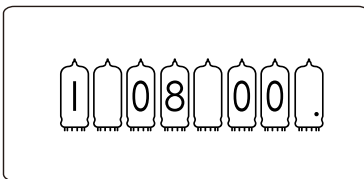

- Press **FUNC** button during display alarm to activate alarm. When alarm is active, the 5th tube will display a dot. Press **FUNC** button again to disable alarm, and the 5th tube will not display a dot.
- The tube on the right will show you if the alarm is enabled for weekends: dot is displayed if alarm is enabled for weekends, no dot displayed if alarm disabled for weekends.

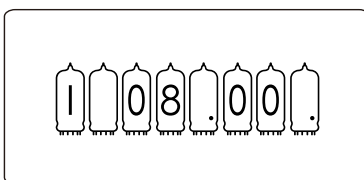

- Divergence Meter will return to time display mode after display alarm for 3 seconds.
- Volume of the alarm setting is adjusted at MENU 14.
- Enable/disable alarm for weekends using SET ALARM.

Set Alarms

- Press **ALARM** button to select alarm, digit on the left will show alarm number.

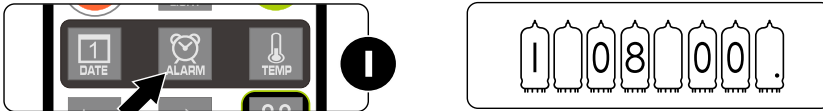

- Press **SET** button to enter alarm set mode, HOUR blinks during setting.

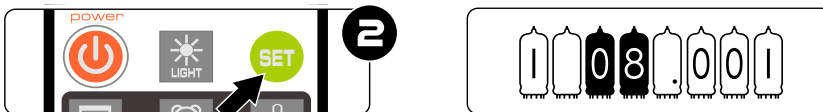

- Press **LEFT/RIGHT** button to select set position.

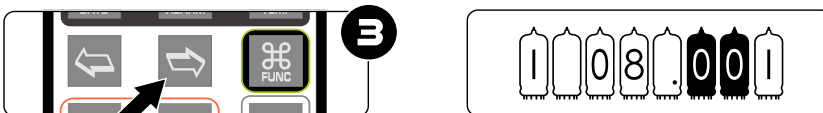

- Press 0-9 button to input HOUR or MINUTE.

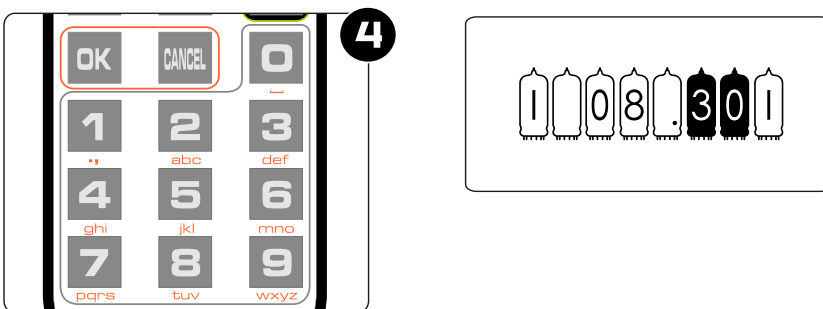

- Digit on the right: 1: enabled for weekend. 0: disabled for weekends.

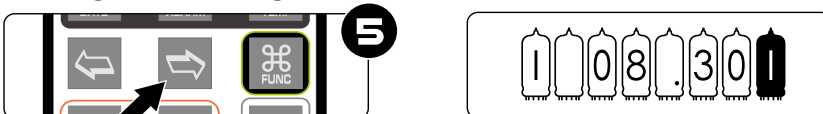

- Press **OK** button to save setting, press **CANCEL** to abort.

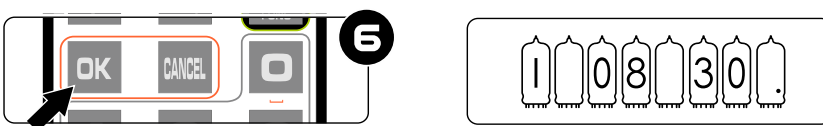

- Any digits can be input during setting, but system will check if the alarm time is valid when you save it. Invalid settings will not be saved.
- Digit on the right can only be set to 0 or 1.
- Consult DISPLAY ALARMS for information on how to enable/disable alarm.

Set Auto On/Off Time

- Press **ALARM** button 5 times to display AUTO ON time, press 6 times to display AUTO OFF time.

Eg: AUTO ON time set to 8:00 AM, AUTO OFF time set to 10:00 PM.

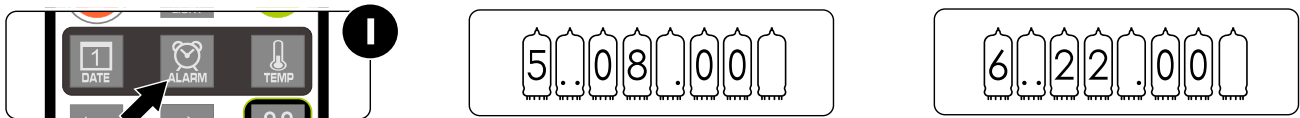

- Press **SET** to enter auto on/off time setting mode, HOUR of auto on/off blinks.

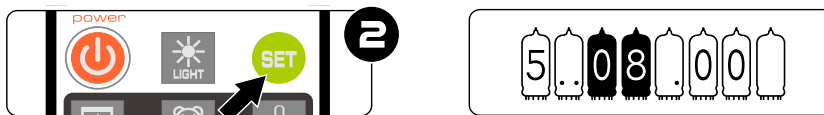

- Press **LEFT/RIGHT** button to select setting position.

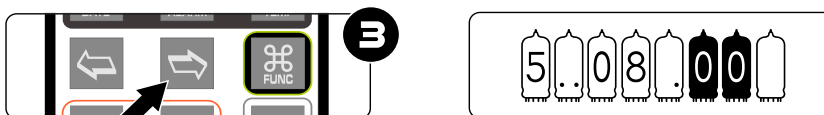

- Press 0-9 to input HOUR or MINUTE.

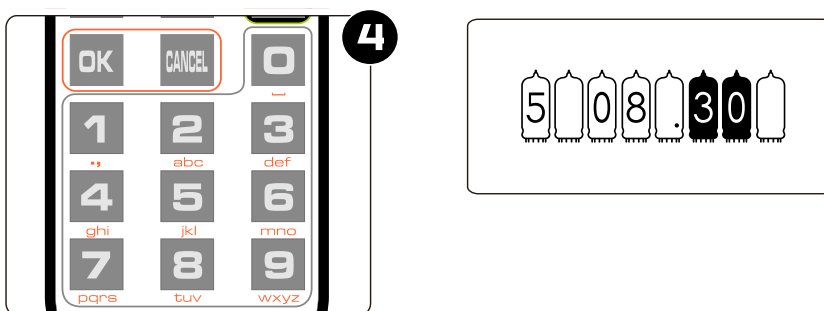

- Press **OK** button to save setting, press **CANCEL** to abort.

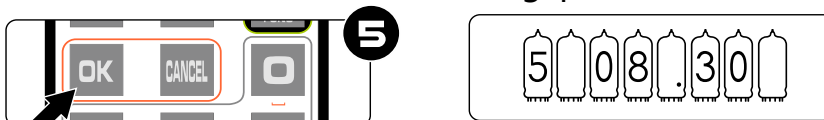

- The 5th digit will show if the auto on/off function is enabled or disabled. Press **FUNC** to toggle auto on/off function between enable and disable.

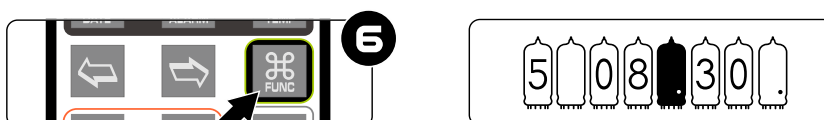

- System will check if auto on/off time is valid. Invalid time will not be saved.
- System default will check auto on/off mode and time every minute.

Display Temperature

Divergence Meter can display temperature of machine using the built-in sensor.

- Press **TEMP** button to display current temperature.

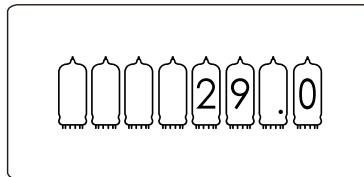

- Divergence Meter will return to time display mode after 3 seconds.
- Temperature unit can be set to °C or °F. Please consult MENU 3.
- Temperature compensation can be set from -5°C to 5°C. Please consult to MENU 12.

Menu

There are 20 different items in the menu for setting system parameters.



- Press **FUNC** button to enter menu.

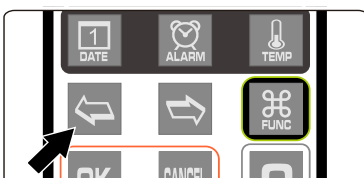

- Press **LEFT/RIGHT** to select menu items.
- Press **SET** button to set current menu item.



- Divergence Meter will return to time display mode after 3 minutes if there are no menu operations.

Menu Setup

There are 20 items in the menu to set parameters.

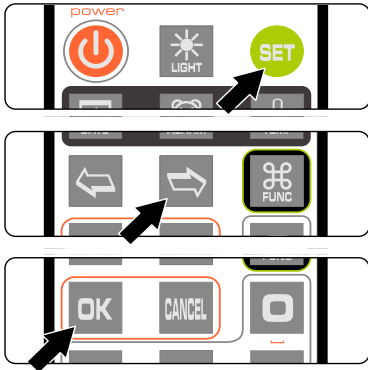

- Press **SET** button to enter setting mode.
- Press **LEFT/RIGHT** button to change setting position.
- Press **OK** to save setting.
- Press **CANCEL** to abort.

Menu 1 Set Time Format

Display	Parameter	Remarks
01.24 1	24 hour	Default
01.12 2	12 hour	

Menu 2 Set Date Format

Display	Parameter	Remarks
02. . . . 1	YY-MM-DD	Default
02. . . . 2	YY-DD-MM	
02. . . . 3	DD-MM-YY	
02. . . . 4	MM-DD-YY	



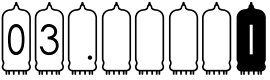
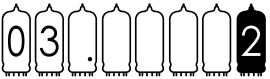

Menu 3 Set Temperature Format

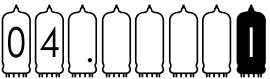
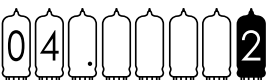
Display	Parameter	Remarks
	°C	Default
	°F	

Menu 4 Set Leading Zeroes

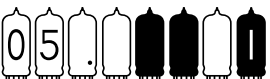
Display	Parameter	Remarks
	On Eg: 08.00.00	Default
	Off Eg: _8.00.00	

Menu 5 Set Digital Switching Effects

Display	Parameter	Remarks
	Normal	
	Fade in-out	
	Cross-fading	Default
	Slot machine	



- The 5th and 6th tubes will demonstrate the effect during setting.

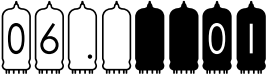
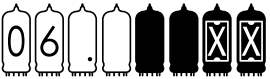
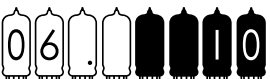

Menu 6 Set Digital Switching Speed

Display	Parameter	Remarks
	01 Fast	
	01-10 10 level in total	Default 07
	10 Slow	

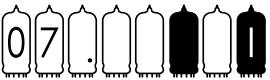
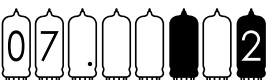

- 5th and 6th tubes will preview switching speed during setting.

Menu 7 Set Blinking Colon Effect

Display	Parameter	Remarks
	Left and right dot crossfading	Default
	Left and right dot fade in-out	
	Always on	
	0.5Hz blinking	



- 6th tube will preview colon blink effect during setting.
- Plus version does not display a left dot.

Menu 8 Set Time Display Mode

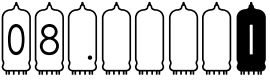
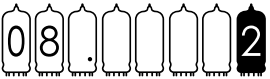
Display	Parameter	Remarks
	Normal 6 digits mode	Default
	Divergence Meter mode	

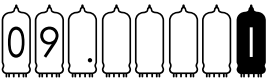
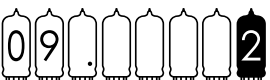

Menu 9 Set Clock Reference Source

Display	Parameter	Remarks
	RTC (built-in Real Time Clock)	
	GPS	Default



- GPS mode requires optional GPS receiver accessory.
- 5th-7th tubes will display connection status. Blank display: no GPS connection. Dot rolling display: connecting. Dot blinking: connected.



Menu 10 Set Baud Rate of GPS

Display	Parameter	Remarks
	2400bps	
	4800bps	
	9600bps	Default

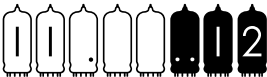
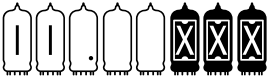
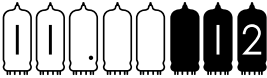
Menu 11 Set UTC Time Zone

Display	Parameter	Remarks
	UTC-12	
	UTC+12 to UTC-12	Default UTC+8
	UTC+12	

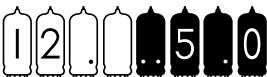
Menu 12 Set Temperature Compensation

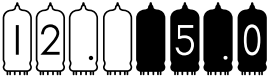
Display	Parameter	Remarks
	-5°C	
	-5°C to 5°C	Default 0°C
	5°C	

Menu 13 Set Alarm Sound

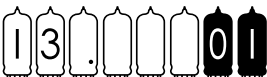
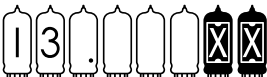
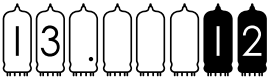
Display	Parameter	Remarks
	No.1	Default
	No.01 to No.12	
	No.12	

Menu 14 Set Alarm Volume

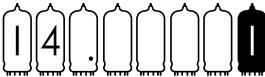
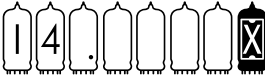
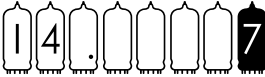
Display	Parameter	Remarks
	Level 1 (min)	
	Level 1 to 7	Default level 5
	Level 7 (max)	

Menu 15 Set Talking Clock Language

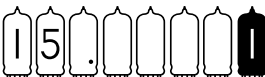
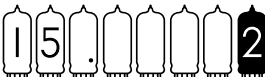
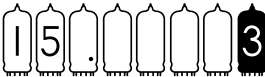
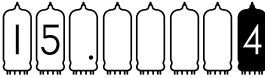
Display	Parameter	Remarks
	Chinese Mandarin	Default
	English	
	Japanese	
	German	

Menu 16 Set Interval of Talking Clock

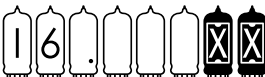
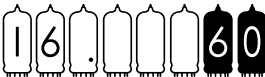
Display	Parameter	Remarks
	Talking clock disabled	
	Minute 0/1/2/3/5/10/15/20/30/60	Default 30 mins
	60 minutes (maximum)	

Menu 17 Set Interval of Divergence Animation

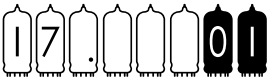
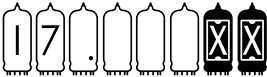
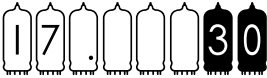
Display	Parameter	Remarks
	1 minute (min)	
	Minute 1/2/3/5/10/15/20/30	Default 10 mins
	30 minutes (max)	



- Divergence animation provides cathode poisoning prevention function.
- For information about cathode poisoning prevention: Please consult last page.

Menu 18 Set Sound Effect of Power On

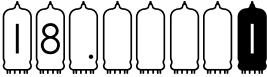
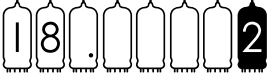
Display	Parameter	Remarks
	Sound effect off	
	Sound effect on	Default

Menu 19 Set Animation Show of Power On

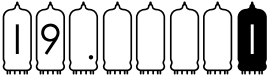
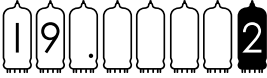
Display	Parameter	Remarks
	Animation off	
	Animation on	Default

Menu 20 Display Firmware Version

Display	Parameter	Remarks
	2.x.x	Firmware version

Firmware Upgrade

Firmware can be upgraded, whenever available, to fix certain problems.

Please download the latest firmware upgrade program and USB driver here:

<http://www.nixieclock.org/?p=649>

Update operation steps:

- Open update software as shown on the left.
- Software interface is shown on the left.
- Connect Divergence Meter with computer with Micro-USB cable.
- Press power button on the back to power off.

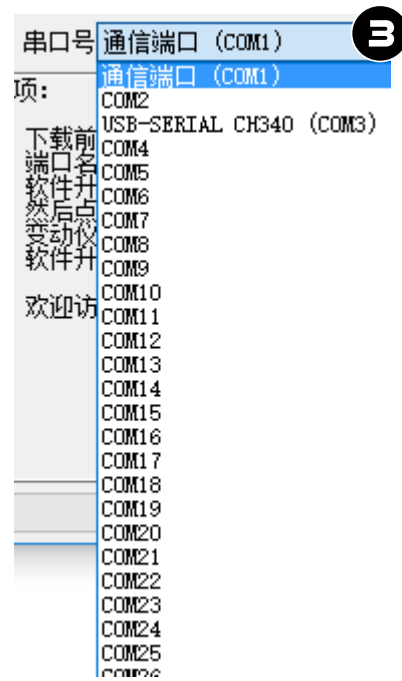
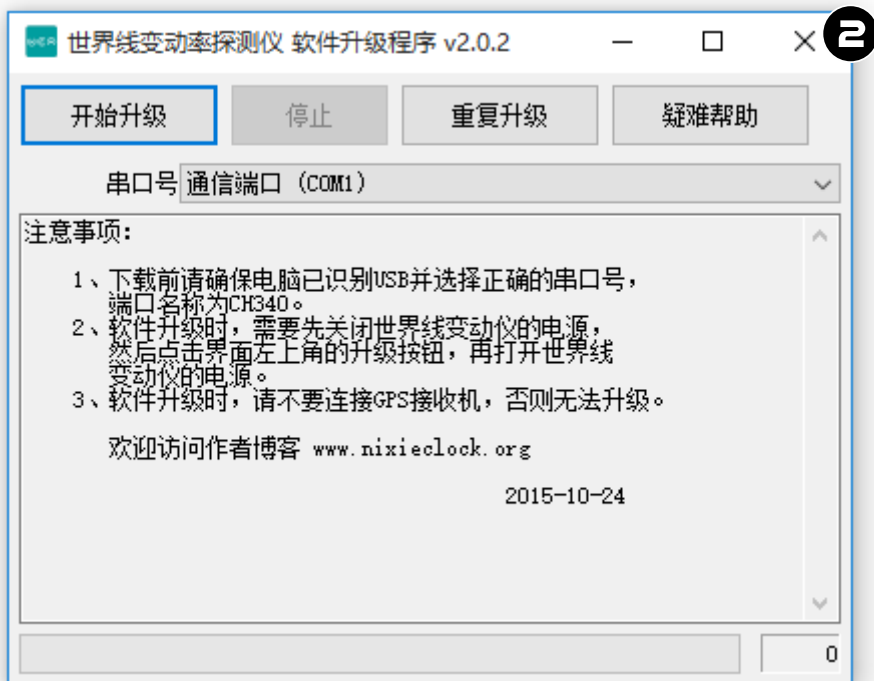

- Please select the serial port named **USB-SERIAL CH340** in the list after USB cable connected.
- Please install ch341ser driver (picture 4) if this serial port is not shown in the list in picture 3.
- Click **Update** button after serial port is selected.
- Push power button to power on (picture 6).
- Upgrade completes after a few seconds.

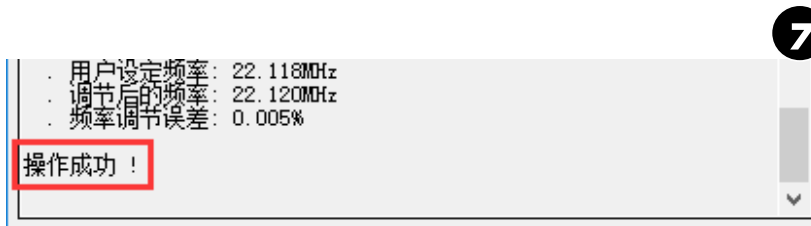
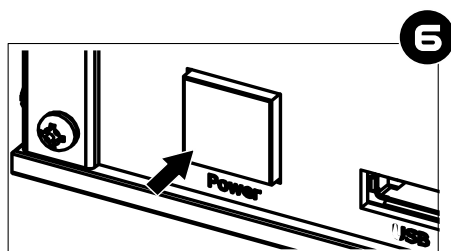

Cathode Poisoning Prevention

Nixie tubes can have an unwanted side effect called 'cathode poisoning'. This is caused by metal molecules of glowing cathodes (digits) attaching to non-glowing cathodes. This can cause digits to become dark in places or entire digits to fail. To avoid this effect, non-glowing or seldom used cathodes have to be switched on from time to time.

Divergence animation will illuminate digits by fast scrolling through all digits, one after another. This feature can be set by MENU 17. The default setting is to animate the digits at a 10 minutes interval. To prolong tube life, we suggest not changing the default.

Special Remarks

- These nixie tubes were produced between 1960 to 1980, and there may be some differences between tubes and manufacturing lots. This is normal, and will not affect the tube operation.
- The Divergence Meter will become warm or little hot during operation due to the internal DC-DC converter and charger circuitry. This is normal operation and no cause for concern.
- The Divergence Meter housing is made from stainless steel and is heavy. Please take care not to drag the unit by the Micro-USB cable to avoid damage to the Micro-USB socket.